

Fill in
the
missing
numbers.

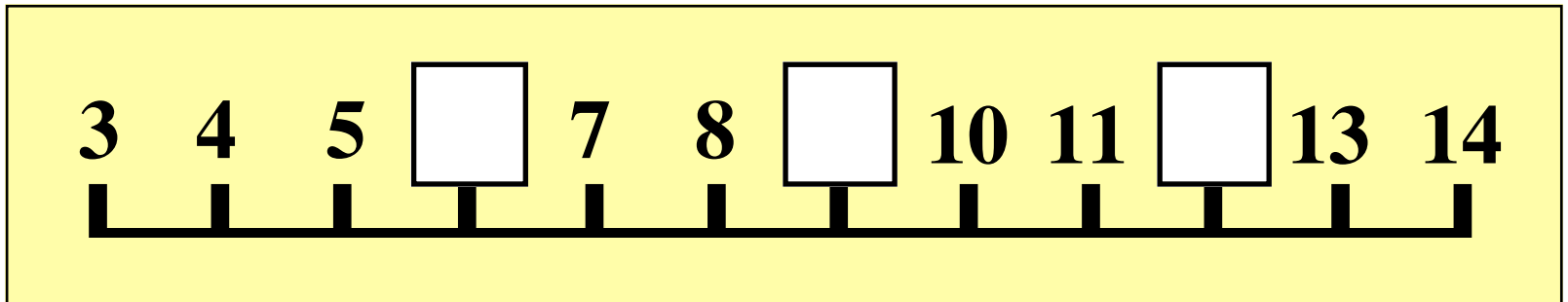

Fill in
the
missing
numbers.

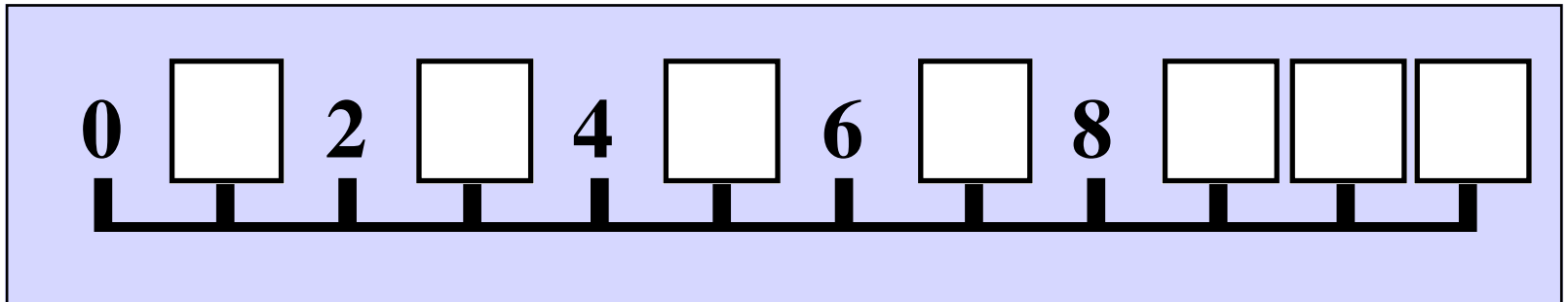
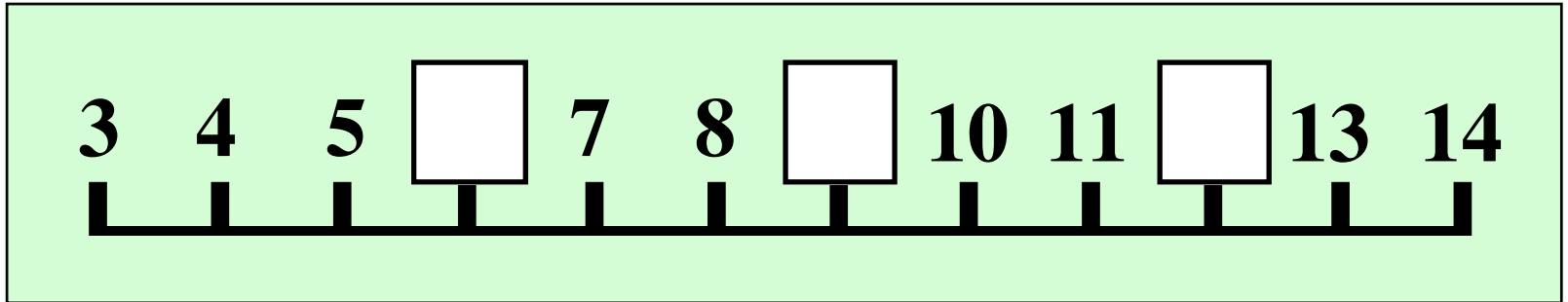
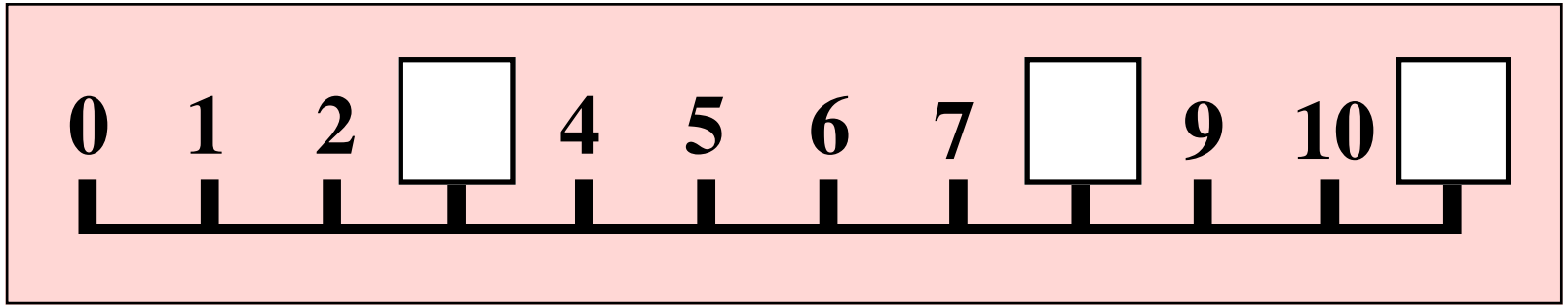
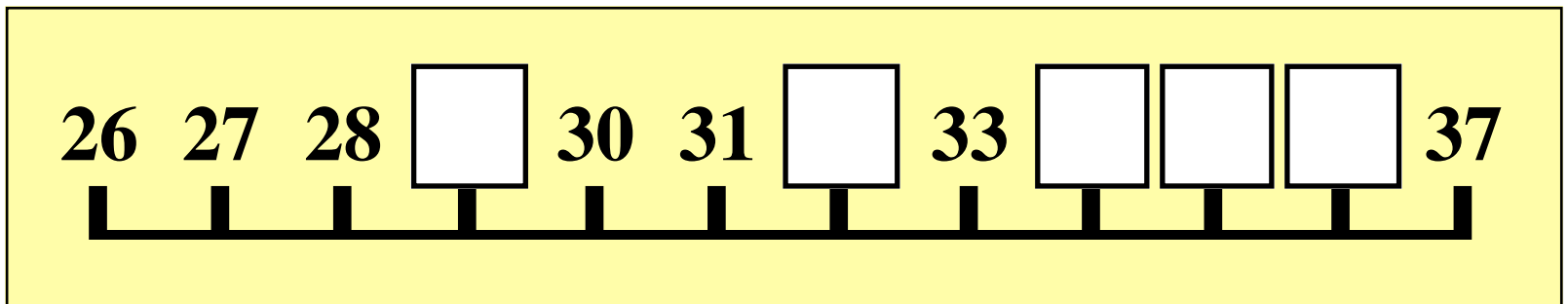
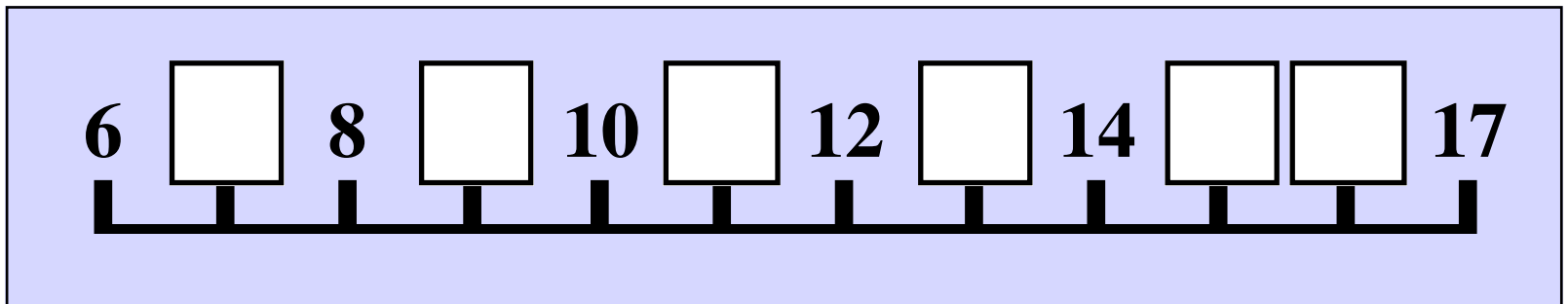
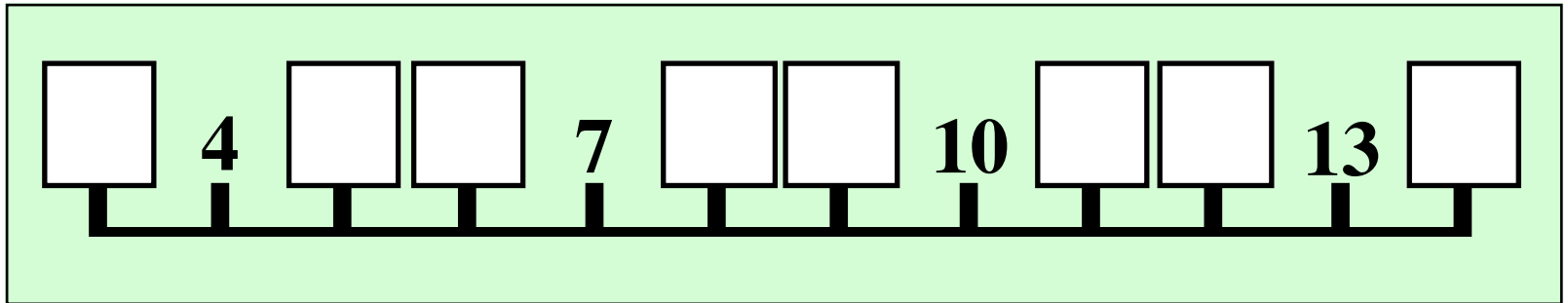
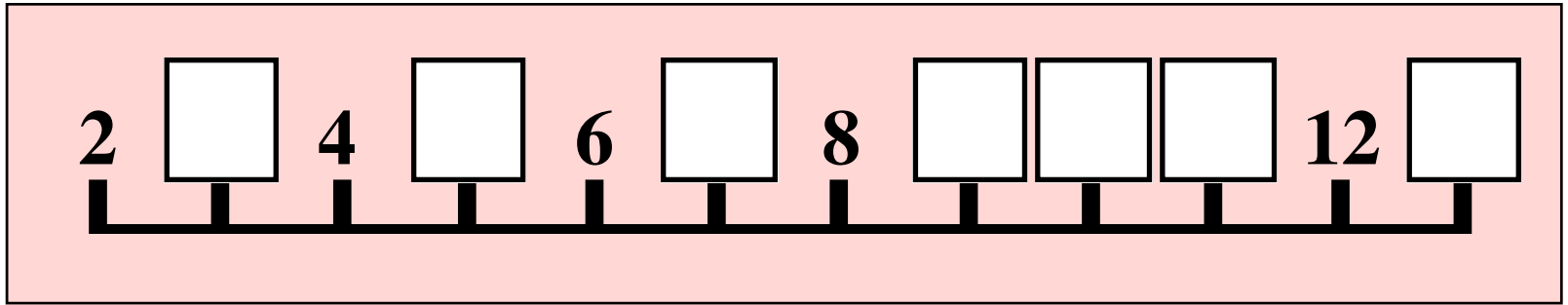

What numbers go in the boxes ?

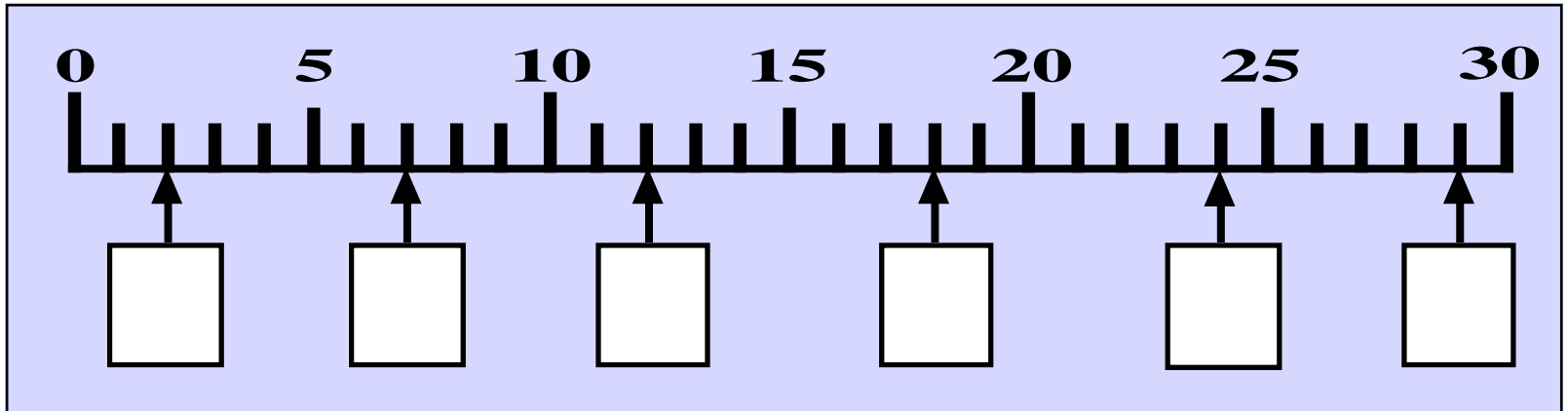
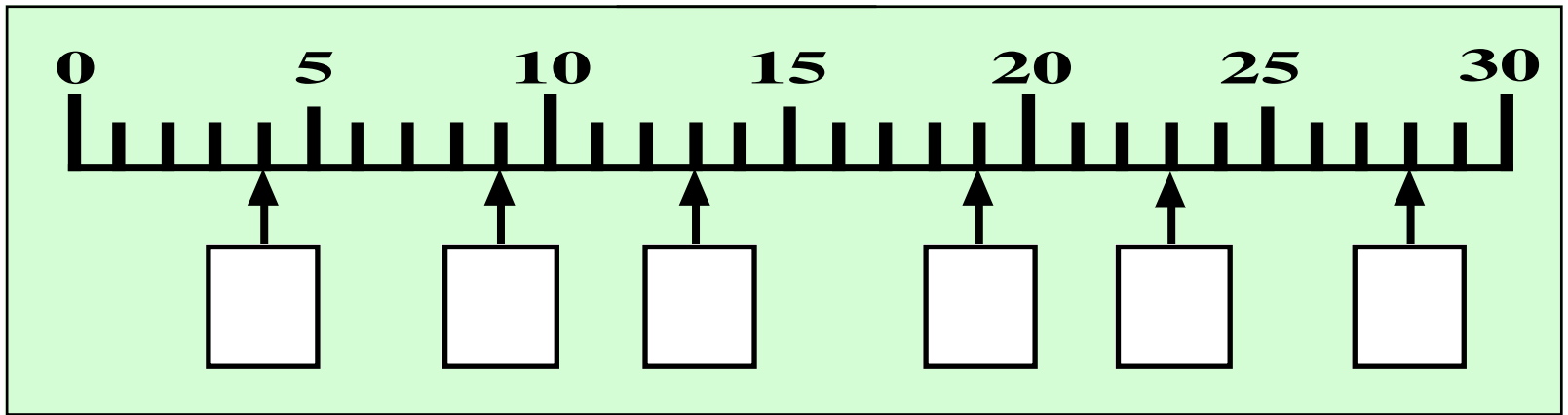
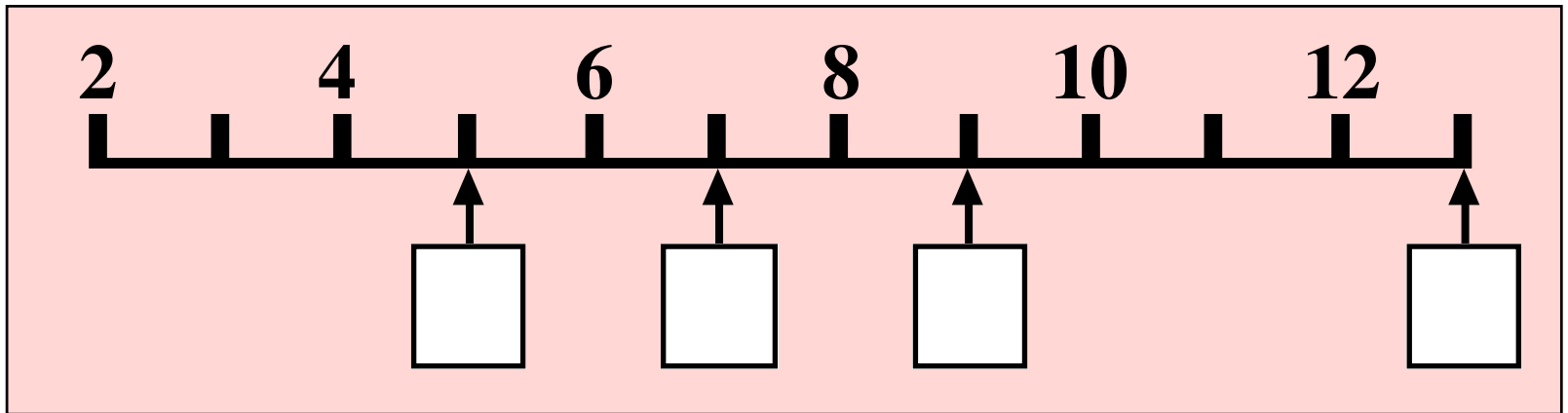

Speeding
or not ?

Tick the
correct
box.



not speeding speeding



not speeding speeding



not speeding speeding



not speeding speeding



Speeding
or not ?

Tick the
correct
box.



not speeding speeding



not speeding speeding



not speeding speeding



not speeding speeding



Speeding
or not?
Estimate
the
speed.

Tick the
correct
box.

50

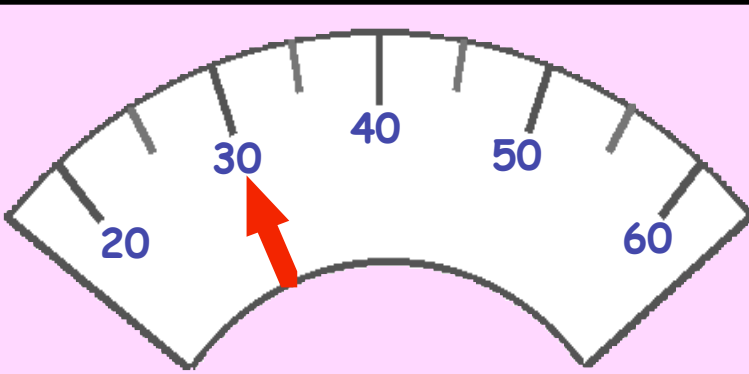

not speeding speeding



speed = mph

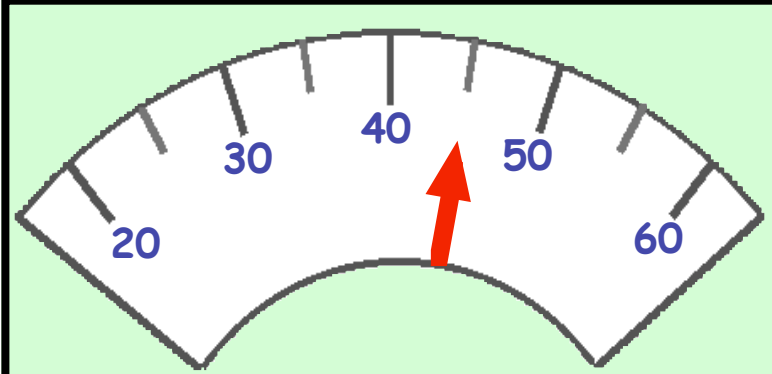

not speeding speeding



speed = mph

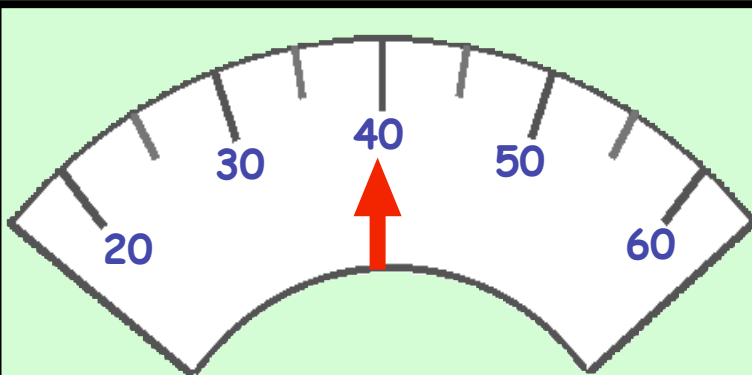

not speeding speeding



speed = mph

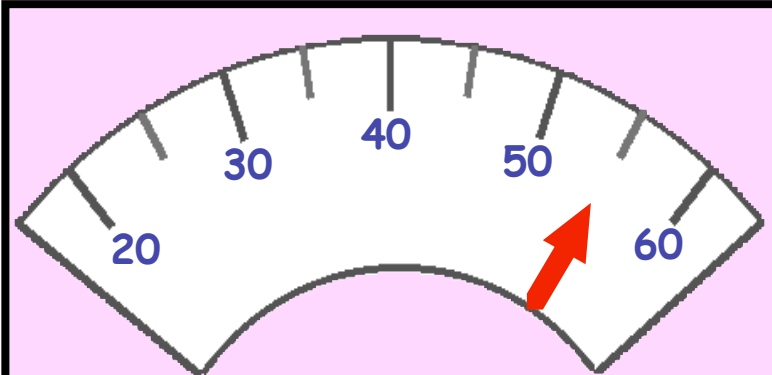

not speeding speeding



speed = mph